



POWER - ALL
Energía Segura, Protección Continua

INDUSTRIAL UPS

DISTRIBUIDOR:



REGULACIÓN Y SISTEMAS DE ENERGÍA

PLAYA SUR No. 20 INT. 2
COL. MILITAR MARTE
08830 IZTACALCO MEXICO, D.F.
TEL. 7090-7088 Y 7090-7089
ventas@regulacionups.com.mx
www.regulacionups.com.mx

INDUSTRIAL UPS SYSTEM



www.regulacionups.com.mx



www.regulacionups.com.mx

DISTRIBUIDOR:



REGULACIÓN Y SISTEMAS DE ENERGÍA

PLAYA SUR No. 20 INT. 2
COL. MILITAR MARTE
08830 IZTACALCO MEXICO, D.F.
TEL. 7090-7088 Y 7090-7089
ventas@regulacionups.com.mx
www.regulacionups.com.mx

Industrial UPS System

Complete Power Solution With Maximum Protection

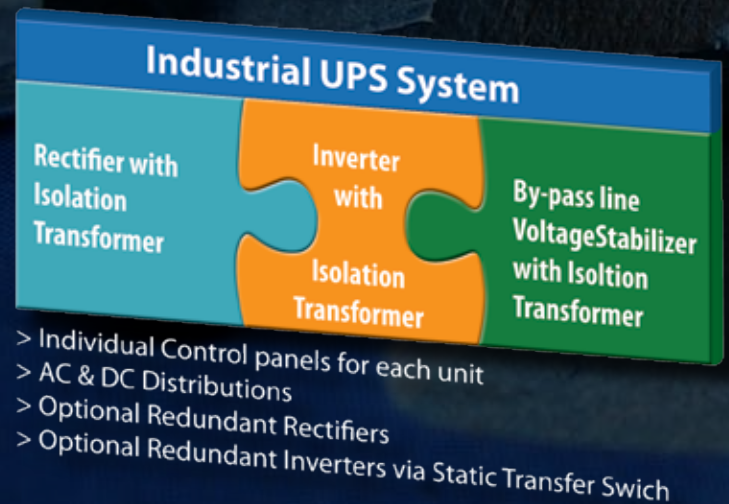

INDUSTRIAL UPS SYSTEM UNITS

The system consists of rectifier / charger, inverter, static bypass, maintenance bypass, rectifier isolation transformer, inverter isolation transformer, bypass line isolation transformer, automatic line stabilizer, DC distribution, AC distribution, controls and monitoring. The AC output of the inverter is connected to the critical load, the storage battery is connected between the inverter

input and rectifier / charger output through a battery isolation MCB. The normal AC input power is connected to the rectifier; the bypass circuit also takes power from the same power source to provide power for the critical load during bypass operation when the system is in maintenance mode.

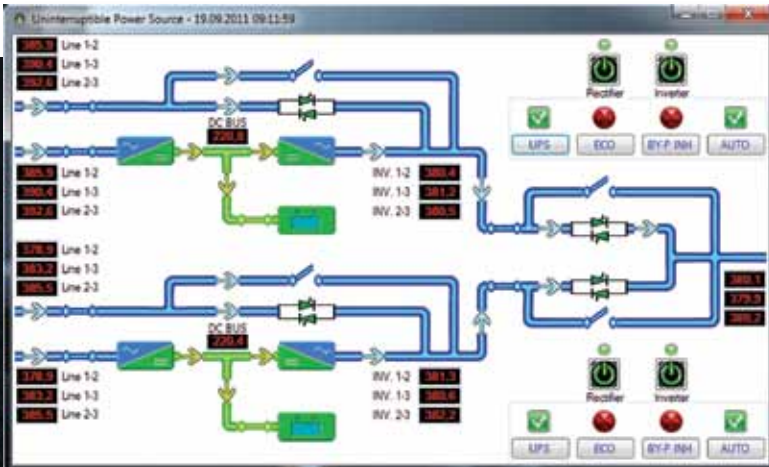

INDUSTRIAL UPS CONCEPT:

Industrial UPSs are regarded as fully customized power supply systems for rugged environments and designed particularly to safeguard critical loads in industrial applications where voltage transients, created by degraded mains supply, can seriously damage both UPS and the critical load. Industrial UPS Systems are fully flexible and customizable and designed for active-on line installation between the power source, by-pass source and critical load where the inverter delivers regulated AC voltage and frequency to the load and rectifier delivers regulated DC voltage / current to the DC load at all times without interruption.

The power conversion process isolates the critical load from the normal mains disturbances and isolates the mains from load induced reflected harmonics affecting other loads connected to the input mains feeder. The rectifier converts AC power into DC to charge maintenance free lead acid or nickel cadmium batteries; it also provides the necessary DC for continuously rated capacity of the inverter. IGBT semiconductor modules are used in PWM inverter and the control logic creates the precise sinusoidal output waveform with a very low harmonic content. Thyristor semiconductor modules are also used in rectifier for reliable operation.



INDUSTRIAL UPS SYSTEM OPERATION MODES

NORMAL OPERATION

The rectifier with input isolation transformer converts normal input AC power into DC for the inverter and DC loads and for charging the battery group. The inverter is synchronized with the mains providing it is within the tolerances permitted by the logic, the inverter delivers its closely regulated frequency and voltage with output isolation transformer through the static switch to the load. Where the reference frequency and voltage are outside the permitted limits, the inverter will 'uncouple' from the mains and will free run using its internal oscillator to assure the high stability power for the load.

LOSS OF INPUT POWER

In the event of input power failure, the inverter will free run using its internal oscillator and DC loads will operate from the battery until the low DC threshold is reached or the input power to the rectifier is restored. When the input AC power to the rectifier is restored, the rectifier resumes the provision of DC for the inverter, DC load and it will simultaneously recharge the battery. The critical AC load connected to the inverter and the critical DC load connected to the rectifier will not be disturbed during the loss and restoration of the input AC power feeding the rectifier.

BYPASS OPERATION

The inverter is provided with a sensing circuit which can delete transient overload, sustained overloads and short circuits. The sensing circuit initiates 'current limit', which causes the static switch to transfer the critical load to the bypass line without interruption for load security. There is also an isolation transformer with automatic line stabilizer. So, bypass line is also a reliable source for the AC load across line fluctuations and disturbances.

Applications

Industrial UPS Systems are primarily designed to meet requirements for the applications;

- Oil and gas offshore and onshore,
- Petrochemical,
- Chemical,
- Power- and Substations
- Production process plants
- Offshore installations
- Pipeline control centers
- Airport, avionics and airfields
- Railways and metro lines
- Hospitals and healthcare
- Security and Alarm equipments
- Defense

TYPICAL REDUNDANT AND FULLY ISOLATED DESIGN

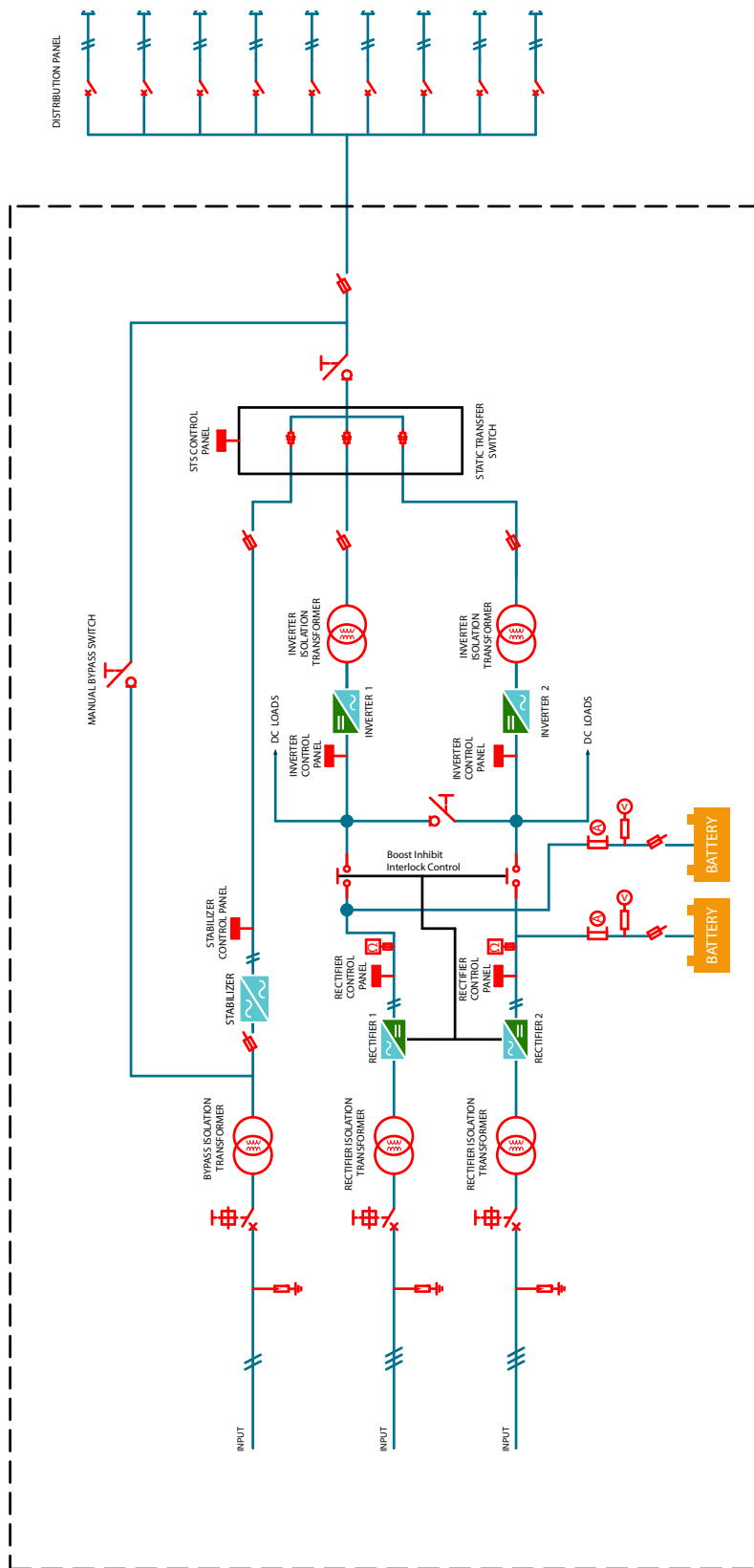

BENEFITS

LOAD SECURITY AGAINST MAINS FAILURE

Load is fully isolated with galvanic transformer. Therefore, in circumstances where the load is likely to be affected by a very large variation in its power supply, a transformer-based UPS provides a safer and more robust solution than transformer-less technology simply because its size and construction afford some inertia between the input and output waveforms, with no additional electronic filtering required. For utmost critical applications like the ones in oil & gas or health care sectors, redundancy on the rectifier side (direct connection) and on the inverter side (via static transfer switch) is highly recommended. **Our Static Transfer Switch topology offers 3-input design:** The 2 inputs are for the UPSs and 3rd input being utilizable as common bypass line for UPSs or as the 3rd redundant line input which is seen as the most important advantage against load sharing systems.

LOAD SECURITY AGAINST BATTERY AND RECTIFIER FAILURE

Load is fully isolated with galvanic transformer. In case of battery or rectifier failure the distorted DC current is filtered out by the transformer, so there is no need to employ additional electronic filtering. In addition due to transformer based architecture less number of electronic components are employed, which brings higher mean time between failure (MTBF) to the system.

MODULAR ARCHITECTURE

UPS systems have a modular architecture, meaning that they're built with a number of electronic cards to control each unit instead of a large, single motherboard; thus it would be enough to replace particular PCB to fix the device in case of a failure. It can be translated into significantly lower spare part cost and shorter maintenance time.

IDEAL SOLUTION FOR INDUSTRIAL USES

Transformer-based devices are ideal for sites that experience heavily polluted mains supplies –particularly industrial, rural and complex infrastructure locations, such as hospitals, petroleum plants, airports etc. In these circumstances, any UPS would be expected to offer dependable long-term protection from repetitive transients and electrical noise.

BATTERY EFFICIENCY

Unlike transformer-less systems, transformer based online UPS systems use fewer number of battery sets to feed the load due to its unique architecture. Therefore battery sets get charged evenly and at optimum rates to maximize the battery life time and reduce long term battery replacement cost. **Our Industrial UPS Systems come with 110 VDC, 125 VDC, 144 VDC, 220 VDC, 264 VDC or 360 VDC bus bar ratings with up to 1000 Amp charging capacity.**

LONGTERM OPERATIONAL EFFICIENCY

PMI transformer based, double conversion online UPS systems provide longer operational efficiency as transformer-less UPS systems bring operational risks and downtime due to malfunction especially for industrial uses where voltage transients, created by degraded mains supply, can seriously damage both UPS and the load.



RECTIFIER BLOCK

The rectifier is SCR controlled AC/DC rectifier with input isolation transformer and with automatic constant voltage and constant current ability. It comes with 6 Pulse or 12 pulse design options depending on user requirements. The advantages of employing 12 pulse rectifier in industrial UPS systems are to have lower THDi (<10%) and higher pf at input (>0.9) as well as to secure redundancy since 12 pulse rectifiers are designed with one delta and one star connected transformers, so the unit itself behaves as two redundant rectifiers by its nature as demonstrated in graphs.

On LCD panel all measurement values, real time base events and failures can be viewed and communicate remotely via RS485-ModBus, TCP-IP or GSM Module. All operations are controlled and processed by micro controllers. Adjustable timer is used for boost charging the batteries automatically. Output current, battery current, boost and Float Charge Voltages are adjustable on the user-friendly control panel. Also automatic boost charge can be selected on menu. The automatic boost menu has the options for selecting the boost and float current according to battery capacity.

For dual operations boost inhibit facility is also provided. Boost Inhibit Function is necessarily employed when two DC Chargers with two battery groups operate in a parallel redundant mode. In parallel operation, if two rectifiers start boost-charging at the same time there is danger the DC load would be damaged by overvoltage. So, the principle idea of Inhibit facility is to block any one of the two chargers feeding the load in Boost mode when the other rectifier is charging the batteries in Boost mode; so the system prevents applying overvoltage to the load. This function is primarily handled by a powerful communication between two rectifiers and the use of contactors.

PROTECTIONS

The input and output of the charger are protected against improper use and line disturbances electronically. Input and output can be switched by circuit breakers individually. It has self-protection against over temperature. The alarm contacts can be used for external system in the case of any anomaly. The output is fully isolated from the AC line input.

12 PULSE RECTIFIER CURRENT WAVE

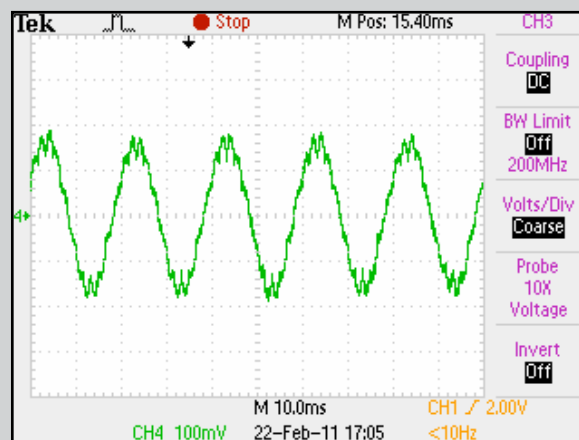

6 PULSE RECTIFIER CURRENT WAVE (DELTA-DELTA CONNECTION)

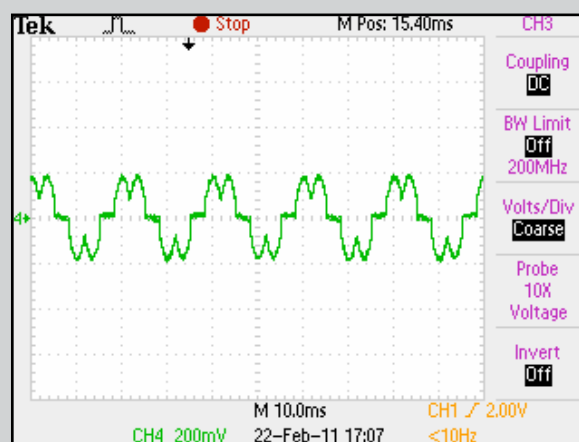

6 PULSE RECTIFIER CURRENT WAVE (DELTA-STAR CONNECTION)

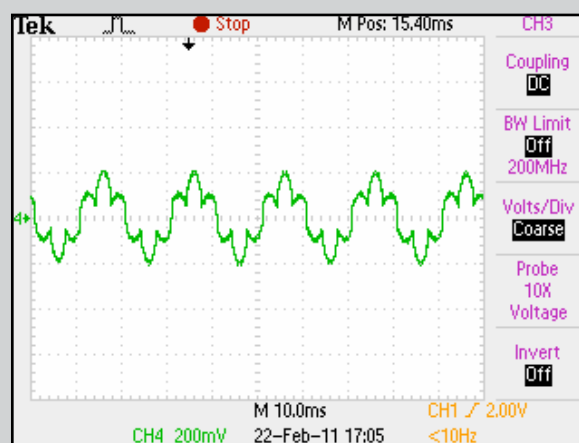

DC Ripple < 1%

Input and output are protected with MCBs and all settings including boost charge, floating charge and battery charge current can be adjusted via front panel digitally. DC output is filtered by L/C, so DC ripple at full load always lower than 1% to increase battery life.

BATTERY CHARGING CHARACTERISTICS

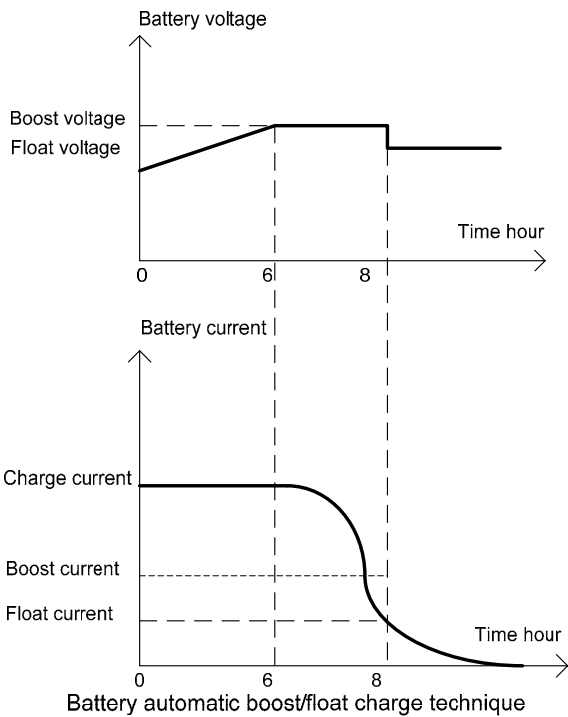

Ideal and safe charging of batteries is sustained by setting boost and float charge currents. In this way unnecessary boost conditions and deformation of batteries at changing load currents are prevented.

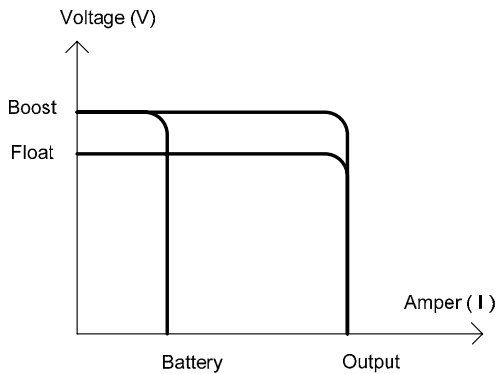

Constant voltage / constant current rectifier output V/I characteristics

Ideal output characteristic via fast microprocessor control

LOW RIPPLE

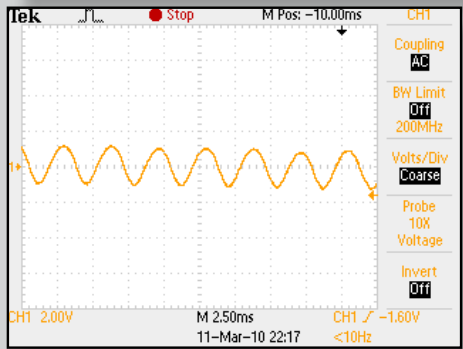
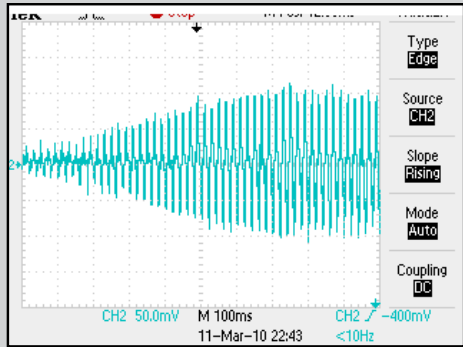

Soft Start Feature

- ▶ No inrush current at start up

AC Ripple at full load < 1%

- ▶ Battery life is extended significantly via low ripple voltage due to low heat

MICROPROCESSOR CONTROL

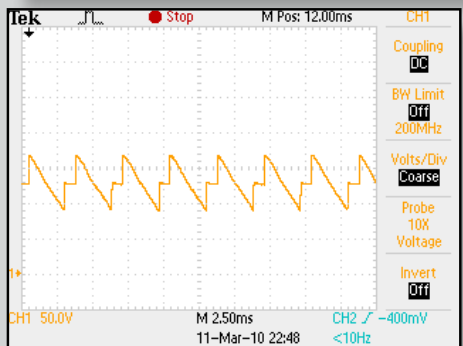
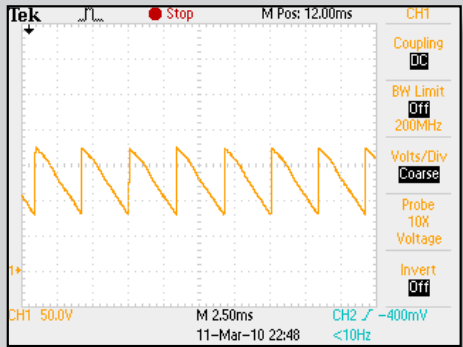

Fully microprocessor controlled rectifier

- ▶ Thyristor angle is adjusted with load change
- ▶ 1/2 Load: Phase angle shortened
- ▶ Full Load: Phase angle at max

DYNAMIC RESPONSE

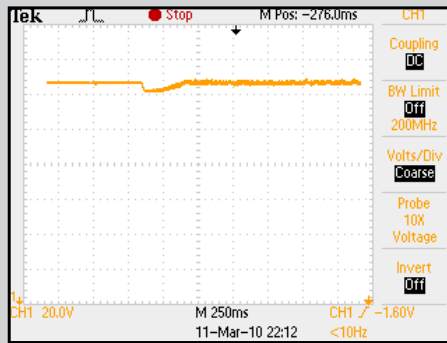
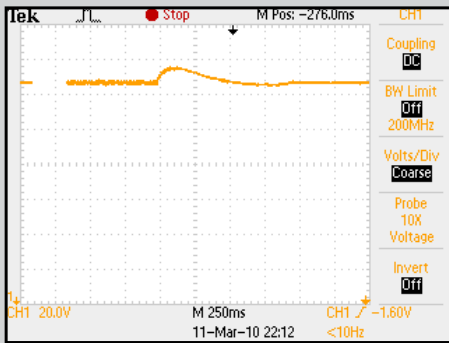

▶ In sudden load changes dynamic response is 300 msec without overshoot or undershoot to secure the load

▶ With this capability rectifier can be used as a power supply even without battery safely with DC Loads

RECTIFIER FRONT PANEL SCREENSHOT

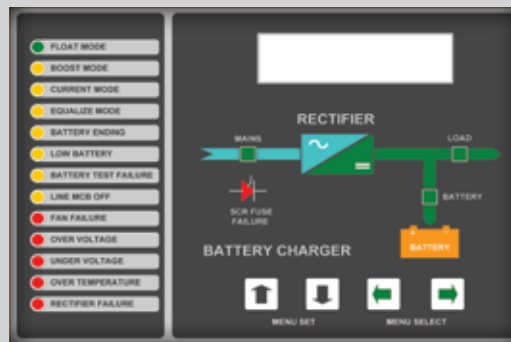

RECTIFIER COMMUNICATION INTERFACE



DISTRIBUIDOR:



PLAYA SUR No. 20 INT. 2
COL. MILITAR MARTE
08830 IZTACALCO MEXICO, D.F.
TEL. 7090-7088 Y 7090-7089
ventas@regulacionups.com.mx
www.regulacionups.com.mx

INVERTER BLOCK

The inverter converts DC voltage into pure sinusoidal AC voltage with constant amplitude and stable frequency. The unit works with an IGBT inverter bridge with PWM (pulse width modulation) having high efficiency in the partial load range as well as achieving a low distortion factor at non linear load. Inverter output encompasses 6 IGBT modules, boosting the instant power capacity of the UPS by double fold with comparison to regular systems. This feature allows the UPS to handle higher capacity loads (inrush currents) with smaller capacity devices. In addition, switching at high frequency - 20 KHz. – keeps the output sin wave (THD) undistorted providing reliable solutions for nonlinear loads. On LCD panel all measure-

ment values, real time base events and failures can be viewed and communicate remotely with RS485 port.

In the event of mains interruption or failure, the battery connected to the DC input feeds the load automatically and without interruption. If the battery discharge limit is exceeded, the inverter automatically turns off and a warning is given shortly before the discharged voltage limit is reached. Automatic change-over of the load to the bypass mains or a suitable spare supply occurs if the supply from the inverter falls outside the preset tolerances.

WARNING LEDS:

- Inverter not Synchronized
- Inverter DC Input High/Low
- Bypass Out of Limit
- Battery Fuse OFF
- Bypass MCB OFF
- Main MCB OFF
- Inverter Overload
- Internal Overtemperature
- Inverter Failure
- IGBT SCR Fuse Failure
- Bypass SCR Fuse Failure
- Inverter Output High / Low
- Fan Failure
- Inverter Overtemperature
- Rectifier Failure
- Battery Test Failure

SET MENU:

- Cold Start ON / OFF
- Automatic Start ON / OFF
- ECO Mode ON / OFF
- Automatic Retransfer Bypass Bypass Inhibit
- DC Cut off Low Battery Level
- Output Adjustment
- Bypass Voltage Tolerance
- Synchronization Frequency
- DC Cut off High Voltage Level

MEASUREMENT VALUES:

- Input Voltage / Current / Frequency
- Output Voltage / Current / Frequency
- DC Voltage / Current
- Internal Temperature

ALARM CONTACTS (1 OPEN 1 CLOSED):

- Inverter Failure
- Inverter Overtemperature
- Inverter Overload
- Load on Bypass / Inverter
- Bypass out of Limit
- Inverter not Synchronized
- Low Battery / Low DC Input
- High DC Input



Dynamic Response

Output at 0-100% load change

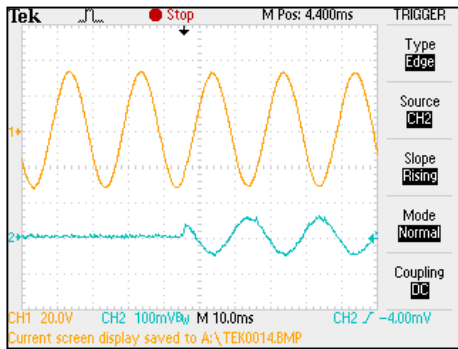

Output at 100% - 0 load change

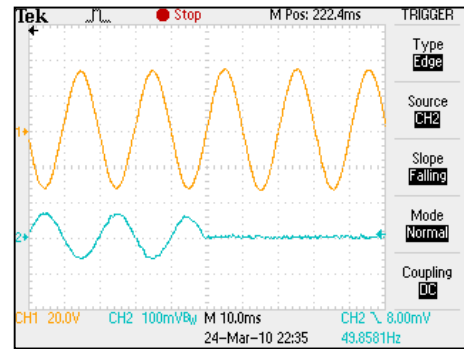

In sudden load changes dynamic response recovery time is 5 msec and max. voltage change is 5%

Switching wave form

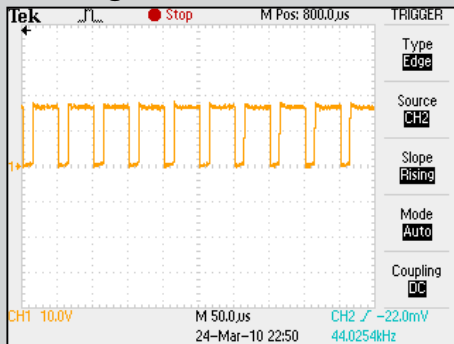

Switching at 20 kHz

- There is no waveform distortion for reactive and nonlinear loads
- Low audible noise

Perfect output waveform with linear loads

Line voltage

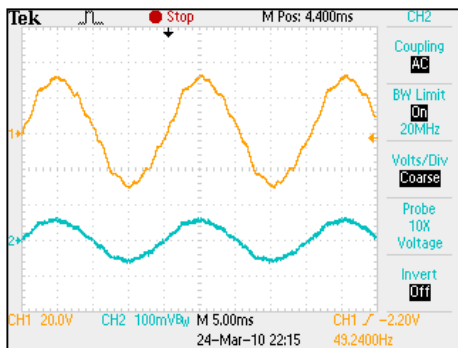

Output waveform

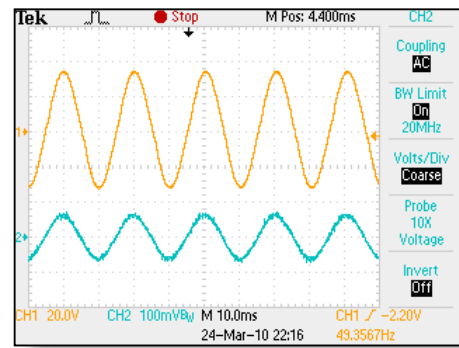

Perfect output waveform with linear loads

Perfect output waveform with non-linear loads

Line voltage

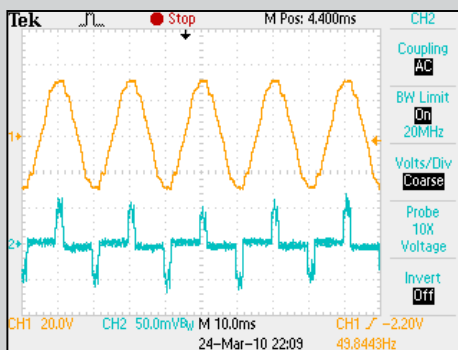

Output waveform

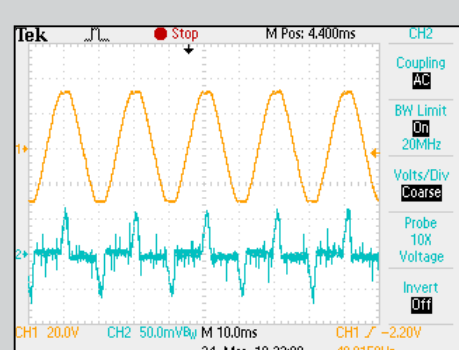

Perfect output waveform with non-linear loads

 **Inverter Communication Interface**



The screenshot shows a software window titled "Uninterruptible Power Source - 19.09.2011 09:19:51". It is divided into three main sections:

- Alarm Relays:** A list of 12 relay types, each with a status indicator (a small circle). The relays are:
 - INVERTER NOT SYNCHRONOUS:
 - INVERTER DC INPUT LOW:
 - INVERTER DC INPUT HIGH:
 - BYPASS OUT OFF LIMIT:
 - BYPASS MCB OFF:
 - INPUT MCB OFF:
 - INVERTER OVERLOAD:
 - INTERNAL OVERTEMPERATURE:
 - IGBT SCR FUSE FAILURE:
 - BACKFEED FAILURE:
 - OUTPUT AC FAILURE:
 - INVERTER OVERTEMPERATURE:
- Device Monitor:** A list of 12 monitoring parameters, each with a corresponding numerical display field. The parameters are:
 - INVERTER FREQUENCY:
 - LINE FREQUENCY:
 - LINE VOLTAGE 1-2:
 - LINE VOLTAGE 1-3:
 - LINE VOLTAGE 2-3:
 - INVERTER VOLTAGE 1-2:
 - INVERTER VOLTAGE 1-3:
 - INVERTER VOLTAGE 2-3:
 - DC VOLTAGE:
 - LOAD 1-2 %:
 - LOAD 1-3 %:
 - LOAD 2-3 %:
 - TEMPERATURE:
- Device Settings:** A section for configuring the device. It includes:
 - A "LOW BAT. VOLTAGE" field with a "SET" button.
 - A time and date configuration section with fields for HOUR (0), MINUTE (0), DAY (1), MONTH (1), and YEAR (11), each with a "SET" button.
 - Fields for "TIME:" and "DATE:" with corresponding display areas.

INVERTER FRONT PANEL

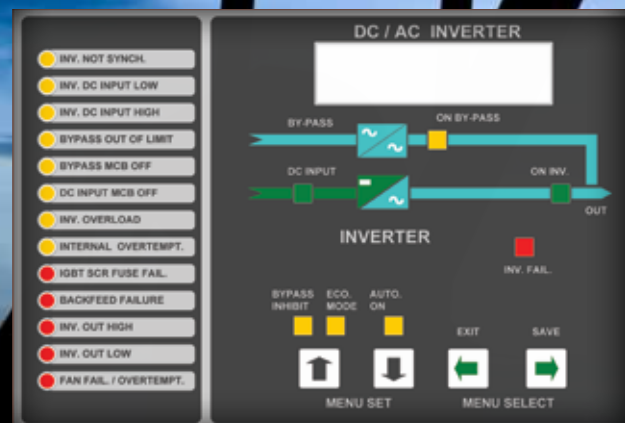

■ STATIC TRANSFER SWITCH BLOCK



The microprocessor-controlled static transfer switch constantly monitors the sources connected to the inputs; checks whether they remain within the current and frequency limits and decides if they are synchronized with each other. If the prioritized source is within the determined limits, critical load is transferred over to the prioritized source. If the prioritized source is not within the determined limits, load is then transferred to the 2nd source which is within the determined limits. When the prioritized source reverts to the determined limits, load is transferred back to it. Source priority can be set via front panel. For synchronization-controlled transfers, the static transfer switch transfers the critical load between sources without interruption. In case of an interruption in the source that feed the critical load, critical load is transferred to the other source within less than 5 ms. If sources are asynchronous to each other and asynchronous transfer is allowed, load is transferred to the other source within less than 11 seconds. If asynchronous transfer is not allowed, asynchronous transfer will not take place. Asynchronous transfer can be enabled via front panel.

Thanks to the 3rd source input on the static transfer switch, a 3rd source or line power can be connected to the system. If a 3rd source is to be used, it can be utilized as the last priority. The 3rd source can also be used as a redundant source input instead of failed lines. This ensures reliability through redundant operation. When static transfer switches are to be used as parallel redundant uninterruptible power sources (UPS), the 3rd source input becomes important because in normal operations, both UPSs first transfer the critical load to the line, namely the bypass lines, in case one of them fails and then the UPS in good condition takes over the load. Even though this happens within a short period of time, the risk of interruption or fluctuation will be present for the line. For static transfer switches with a 3rd source input, the critical load is transferred to the line only if both UPSs fail.

Since the static transfer switches have 3 inputs, the 3rd source input functions as the common bypass line of the UPS's when parallel redundant UPSs are employed. This ensures true parallel redundant operation without utilizing bypass from UPSs. Also if the critical load exceeds 100% on the static transfer switches, the load is uninterruptedly transferred to the 3rd source thus preventing unnecessary shutdown or interruption.

Static transfer switches are capable of detecting thyristor failure and transfer the load to a convenient source thanks to the microprocessor control. It indicates a failure warning and shows the failed thyristor module block on the front panel. If the failure of this source's thyristor block can not be eliminated, the load is not transferred to this source again.

Perfect output waveform with non-linear loads

Source 1 is off limits

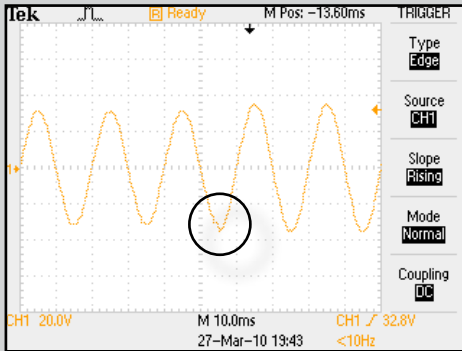

Transfer from Source 1 to Source 2 at the peak value of the line with forced commutation

Blackout on Source 1 at peak

(Worst case scenario)

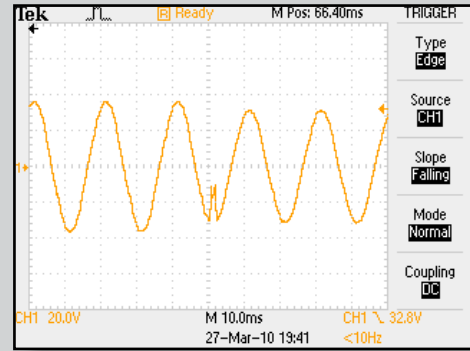

Perfect synchronized transfer to Source 2 at 2 msec

STS FRONT PANEL

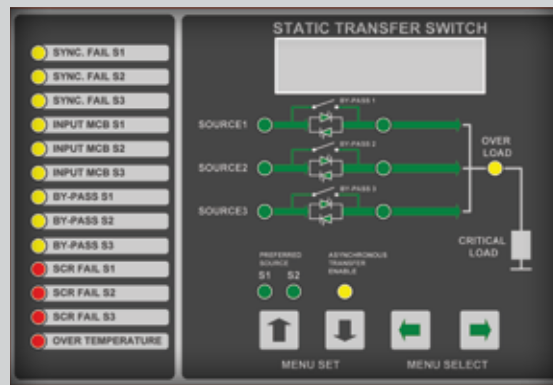

STS COMMUNICATION INTERFACE



VOLTAGE STABILIZER AND ISOLATION TRANSFORMER AT BYPASS

In-house developed Servo & Static Type regulators stabilize the mains changes ideally when the Industrial UPS system is on bypass mode. It is particularly employed when differences exist at input and output voltage in the bypass mains. In this case, the bypass transformer adjusts the input to the output voltage; the stabilizer offsets the input mains variations and keeps the output voltage stable; so the voltage between the phases and voltage varieties are stabilized by these safe systems.

Since the output voltage tolerance is low ($\pm 1\%$) for Servo Type Stabilizers, it is an ideal solution for protecting loads when the UPS is on Bypass Mode. However places where

the mains changes frequently (20-50 VAC), the mechanical fault possibility increases as the mechanical servo needs to move frequently to compensate the input voltage variations. In addition, the regulation speed may not be enough to stabilize line input. In such cases Static Stabilizer may be a better solution which has no mechanical failure risk because static stabilizers don't include any moveable parts. Also for static stabilizers the speed of regulation is higher than servo stabilizers (500 V/sec) so the response of the system is better for instant mains changes. However output voltage tolerance ($\pm 2\%$) is worse than servo stabilizers.

UNINTERRUPTED SWITCHING (STATIC STABILIZER OPTION)

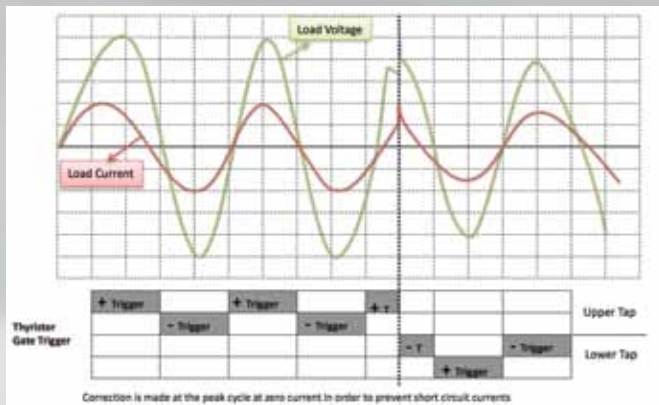

Reliable and uninterrupted switching is secured as tap changing occurs at zero current and at voltage peak level during regulation (shown on the diagram). Thanks to this feature, the occurrence of short circuit at switching instant is prevented.

SAFER LOAD (SERVO STABILIZER OPTION)

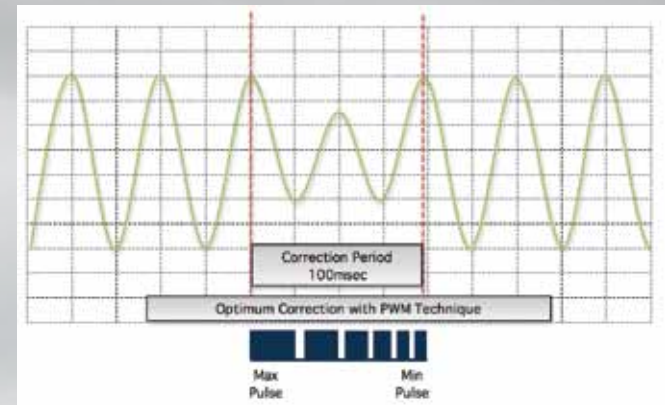

Since Servo Motor is set in motion with PWM technique, Servo Regulator responds to voltage spikes at optimum pulses to prevent overshoot & undershoot type corrections. As a result, the load is safer against voltage surges and short circuit current. In addition optimum corrections extend the life of the variable transformer and the regulator itself.



TECHNICAL SPECIFICATIONS

DISTRIBUIDOR:



REGULACIÓN Y SISTEMAS DE ENERGÍA

PLAYA SUR No. 20 INT. 2
COL. MILITAR MARTE
08830 IZTACALCO MEXICO, D.F.
TEL. 7090-7088 Y 7090-7089
ventas@regulacionups.com.mx
www.regulacionups.com.mx

GENERAL

Power Range	1-1 PHASE/ 1, 2, 3, 4, 5, 6, 7.5, 10, 15, 20 KVA
	3-1 PHASE / 10, 15, 20, 30, 40, 60 KVA
	3-3 PHASE / 10, 15, 20, 30, 40, 60, 80, 100, 125,150, 200 KVA"
Topology	Double Conversion Online System with Output Isolation Transformer
Control	Microprocessor Controlled System

RECTIFIER

Topology	Full Bridge Phase Angle Controlled Thyristor Module Rectifier (6 Pulse / 12 Pulse Options)
Control	Microprocessor Controlled System
Nominal Input Voltage	110 VAC / 220 VAC / 230 VAC / 240 VAC / 380 VAC / 400 VAC / 415 VAC / 480 VAC ±15%
Nominal Input Frequency	50 hz. ±5% or 60 hz. ±5%
Input Power Factor	>0.8 Inductive (>0.9 with 12 Pulse Rectifier)
Nominal DC Voltage	110 VDC / 125 VDC / 144 VDC / 220 VDC / 264 VDC / 360 VDC
Nominal DC Current	Available upto 1200 Amp (12 Pulse over 400 Amp)
Static Tolerance	<1%
Output Voltage Ripple RMS	<1% (at full load)
Input Isolation Transformer	Galvanically Isolated (optional)
Serial Dropper Diodes	Optional depending on DC load input voltage range
Total harmonic Distortion (ThDi)	<30% (standard); <10% (with 12 Pulse Rectifier)
Battery Charging Principle	Constant Current Constant Voltage
Battery Charging Current Range	0-20 Adjustable based on Battery Current (standard); Can be higher based on Battery Capacity
Float Charge Voltage	100% to 115% of Floating Output Voltage Programmable
Boost Charge Voltage	100% to 125% of Floating Output Voltage Programmable
Boost voltage (V/C)	2,4 lead acid battery 1,55 NiCd Battery
Float voltage (V/C)	2,23 lead acid battery 1,40 NiCd battery
Equalize voltage (V/C)	2,7 lead acid battery 1,7 NiCd battery with reduced current
Front Panel Measured Values	LCD Display for Load Output Voltage / Current , Battery Output Voltage / Current and Line Voltage / Line Current / Frequency
Alarm Contacts (1 Open 1 Closed)	Open or closed; rectifier failure, over voltage, low battery, over temperature, line failure, Input MCB, Load MCB, Battery MCB
Front Panel Indicators	Float mode, Boost mode, Current mode, Boost inhibit, Battery ending, Low battery, Battery test failure, Line failure, Fan failure, Over voltage, Under voltage, Over temperature, Rectifier failure, SCR fuse failure (LED indication), Line MCB (LED indication), Load MCB (LED indication), Battery MCB (LED indication)
Front Panel Set Menu	Boost charge voltage, Float charge voltage, Low battery voltage , Battery test , Charger output current, Battery charge current, Battery automatic boost current and float current, Auto & Manual boost selection, Manual boost time, LED test and On - OFF.
Event History	Last 250 events recorded and displayed on front panel and on PC via RS 485
Communication	Parameter monitoring and setting through RS 485/Modbus over local area network or through RS485/TCP-IP over internet

TECHNICAL SPECIFICATIONS

Protections	Input: Thermic-Magnetic Over Current Protection, Over Voltage Protection, Phase Sequence Free Operation (3 Phase), Soft Start
	Output: Short Circuit Protection, Over Voltage Protection, Reverse Voltage Protection
	Battery: L-C filters, Overcurrent Electronic protection, Over Voltage Protection and Thermic Fuse
INVERTER	
Topology	3 Full Bridge 6 high Frequency IGBT Inverter Modules (3 Phase); 1 Full Bridge 2 high Frequency IGBT Inverter Modules (1 Phase)
Power Factor	0.8
Nominal Input Voltage	110 VDC / 125 VDC / 144 VDC / 220 VDC / 264 VDC / 360 VDC
Operating Input Voltage	±15%
Nominal Output Voltage	110 VAC / 220 VAC / 230 VAC / 240 VAC / 380 VAC / 400 VAC / 415 VAC / 480 VAC
Voltage Tolerance	
static	± 1%
dynamic with 100% load change	± 5% in 5 msec.
Overload	
at 125% Load	10 minutes
at 150% Load	1 minute
at 300% Load	1 second
Waveform	Pure Sinusoidal
Total Harmonic Distortion (ThDv)	
at Linear Load	< 3%
at Non-Linear Load	< 5%
Crest Factor	3 : 1 (1 second)
Angle Deviation / Static Tolerance Deviation	
symmetric load	-- < 1° / <1%
50% asymmetric load	-- < 1° / <1%
100% asymmetric load	-- < 1° / <1%
Nominal Output Frequency	
while synchronized with the line	50 hz ±2% or 60 hz ±2%
while not synchronized with the line	50 hz ± 0.1% or 60 hz ± 0.1%
Switching Frequency	20 Khz.
Efficiency with Nominal Load	>85% / >90% depending on DC Bus Voltage
Isolation Transformer	Galvanically Isolated (standard)
Short-circuit behaviour:	3 x Nominal Output Current
Protection	Short Circuit Protection, Over Voltage Protection, Under Voltage Protection, Over Current Protection and Over Temperature Protection
Paralleling	Provided through precision synchronizing technique OR through Static Transfer Switch
Communication	Parameter monitoring and setting through RS 485/Modbus over local area network or through RS485/TCP-IP over internet

TECHNICAL SPECIFICATIONS

Front Panel Warnings	Inverter not Synchronized, Inverter DC Input High/Low, Bypass Out of Limit, Battery Fuse OFF, Bypass MCB OFF, Main MCB OFF, Inverter Overload, Internal Overtemperature, Inverter Failure, IGBT SCR Fuse Failure, Bypass SCR Fuse Failure, Inverter Output High / Low, Fan Failure, Inverter Overtemperature, Rectifier Failure, Battery Test Failure
Front Panel Set Menu	Cold Start ON / OFF, Automatic Start ON / OFF, ECO Mode ON / OFF, Automatic Retransfer Bypass Bypass Inhibit, DC Cut off Low Battery Level, Output Adjustment Bypass Voltage Tolerance, Synchronization Frequency, DC Cut off High Voltage Level
Alarm Contacts (1 Open 1 Closed)	Inverter Failure, Inverter Overtemperature, Inverter Overload, Load on Bypass / Inverter, Bypass out of Limit, Inverter not Synchronized, Low Battery / Low DC Input, High DC Input
STATIC TRANSFER SWITCH	
Topology	Thyristor controlled transfer switch
Nominal Voltage	110 VAC / 220 VAC / 230 VAC / 240 VAC / 380 VAC / 400 VAC / 415 VAC / 480 VAC ±10%
Nominal Frequency	50 Hz or 60 Hz
Operational Current	50 A / 100 A / 200 A – 1 Phase; 3x50 A /3x100 A /3x200 A /3x 300 A-3 Phase
Operation Voltage Interval	± 10% Adjustable
Synchronization Interval	± 10% Adjustable
Frequency Interval	± 10% Adjustable
Load Power Factor	0,7 – 1 Inductive
Overloading Capacity	
Between 100% - 125%	10 min.
Between %125 - 150%	5 sec.
Between %150 - 300%	100 msec.
Transfer Management	Break before make
Synchronous Transfer Time	< 5 msec. (¼ cycle at 50 Hz)
Asynchronous Transfer Time	< 11 msec.
Other Controlled Transfers	0 msec.
Efficiency	>99%
Communication	Parameter monitoring and setting through RS 485/Modbus over local area network or through RS485/TCP-IP over internet
Protection	Over temperature Protection, Thermal Fuse Protection at Source Inputs , Over-voltage Protection at Source Inputs
Front Panel Indications and Warnings	Synchronization Failure (Light), Asynchronous Transfer Enabled (Light), Prioritized Source Preference (Light), Input Source Fault (Light and Sound), Over current (Light and Sound), Over temperature (Light and Sound), Thyristor Failure (Light and Sound)

TECHNICAL SPECIFICATIONS

Buttons	"Asynchronous Transfer Enable" Button, "Manual Transfer Enable" Button, " Reset" Button, "Source 1 or Source 2 Preferred" Button
Manuel Bypass	0 (Off) / 1 (1st Source) / 2 (STS Output) / 3 (2nd Source) Selector Switch
STATIC BY-PASS	
Topology	Uninterruptible static switch with back-feed protection
Bypass System	No break semiconductor thyristor
Nominal Voltage	110 VAC / 220 VAC / 230 VAC / 240 VAC / 380 VAC / 400 VAC / 415 VAC / 480 VAC ±10%
Nominal Frequency	50 hz ± 2% or 60 hz ± 2%
Load Level	500% 1 second
Bypass Isolation Transformer	Galvanically Isolated (optional)
Voltage Stabilizer	Servo or Static Controlled with front panel (optional)
Inverter/Bypass transfer time	
Inverter failure	Max. 5 msec.
Overload or manual transfer	0 msec.
Bypass/Inverter transfer time	0 msec.
Efficiency	>99%
Voltage Tolerance	± 10%
SAFETY	
Over Voltage Protection	IEEE 587 4500 A, 110 Joules (standard), 40 kA 1000 joules surge arrestor (optional)
Electrical Interference Reduction	FCC Part 15 Class B
Electrical Standards	EN 50091-1 (Security) / EN 50091-2 (EMC)
Protection Level / Color	IP 20 / RAL7035, available upto IP42
MTBF	100,000 hrs. (w/out battery group)
Enclosure Material	Mild Steel, Zinc-phosphate coated; 100 µm electrostatic paint; 1.5 mm thickness
Panel Lighting	Optional
Cooling	Forced fans with redundant fans (optional natural cooling)
Cable Entry	Bottom (optional top entry)
Distribution	AC and DC available on request
Output Connections	1 Ph 2W, 3 Ph 3W, 3Ph 4 W
Dimensions	Range of options available and vary based on customized configuration
Operating Temperature	-10 / +40 °C
Relative humidity	5 - 90 %
Operating Altitude	Max. 2000 Mt.
Noise Level	Max. 60 db



POWER - ALL

Energía Segura, Protección Continua

DISTRIBUIDOR:



REGULACIÓN Y SISTEMAS DE ENERGÍA

PLAYA SUR No. 20 INT. 2
COL. MILITAR MARTE
08830 IZTACALCO MEXICO, D.F.
TEL. 7090-7088 Y 7090-7089
ventas@regulacionups.com.mx
www.regulacionups.com.mx

www.regulacionups.com.mx

