



NP7-12 NP7-12FR

Sealed Rechargeable
Lead-Acid Battery

12V, 7.0Ah

Specifications

- **NOMINAL VOLTAGE:** 12V
- **NOMINAL CAPACITY:**
 - 20 hr. rate of 0.35A to 10.5V 7.0Ah
 - 10 hr. rate of 0.65A to 10.5V 6.5Ah
 - 5 hr. rate of 1.19A to 10.2V 5.95Ah
 - 1 hr. rate of 4.20A to 9.60V 4.2Ah
- **WEIGHT (approx.):** 6.17 pounds (2.80 kgs.)
- **ENERGY DENSITY (20 hr. rate):** 1.49 WH/cubic inch (91.0 WH/liter)
- **SPECIFIC ENERGY (20 hr. rate):** 13.6 WH/pound (30 WH/kg)
- **INTERNAL RESISTANCE OF CHARGED BATTERY:** 30 milliohms (approx.)
- **MAXIMUM DISCHARGE CURRENT WITH STANDARD TERMINALS:** 40 amperes
- **MAXIMUM SHORT-DURATION DISCHARGE CURRENT:** 210 amperes
- **OPERATING TEMPERATURE RANGE:**
 - CHARGE 5°F to 122°F (-15°C to 50°C)
 - DISCHARGE -4°F to 140°F (-20°C to 60°C)
- **CHARGE RETENTION (shelf life) at 68°F (20°C):**
 - 1 month 97%
 - 3 months 91%
 - 6 months 85%
- **LIFE EXPECTANCY:**
 - STANDBY USE 3 to 5 years
 - CYCLE USE (approx.):
 - 100% depth of discharge 250 cycles
 - 50% depth of discharge 550 cycles
 - 30% depth of discharge 1200 cycles
- **SEALED CONSTRUCTION:** Can be operated in any position without leakage.
- **STANDARD TERMINAL:** Quick Disconnect .187 or Optional .250
- **HOUSING MATERIAL:** ABS Resin
- **OPTIONAL:** Container and cover made from Flame Retardant ABS (UL94-V0/L.O.I.>28%)

Terminal

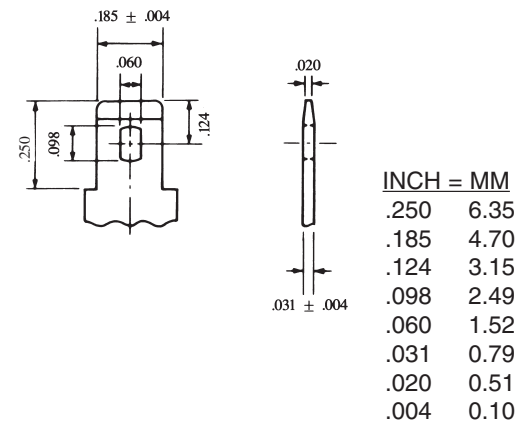

Dimensions

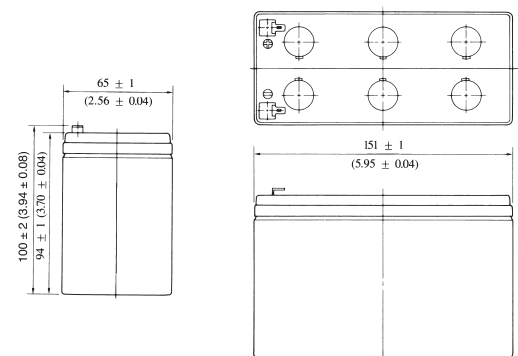

DIMENSIONS: MM (INCHES)

UL listing pending - File No MH16464

www.regulacionups.com.mx

EnerSys™
Power/Full Solutions

DISTRIBUIDOR:



REGULACIÓN Y SISTEMAS DE ENERGÍA

PLAYA SUR No. 20 INT. 2
COL. MILITAR MARTE
08830 IZTACALCO MEXICO, D.F.
TEL. 7090-7088 Y 7090-7089
ventas@regulacionups.com.mx
www.regulacionups.com.mx

DISCHARGE CHARACTERISTIC CURVES AT 25°C (77°F)

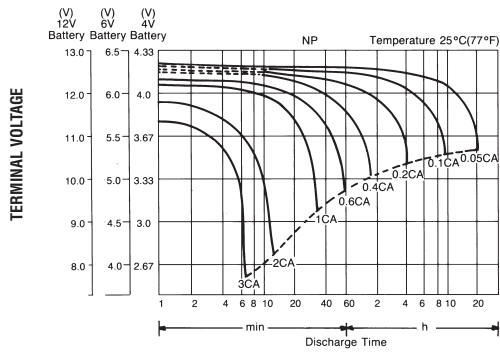

TEMPERATURE EFFECTS IN RELATION TO BATTERY CAPACITY

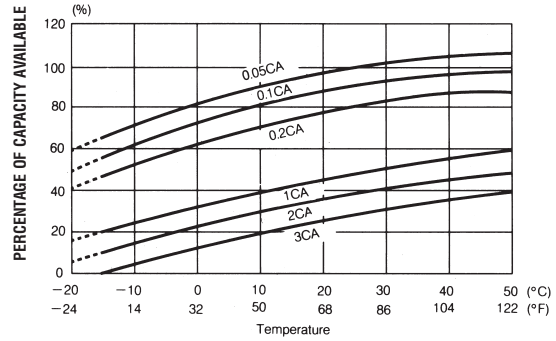

SELF DISCHARGE CHARACTERISTICS

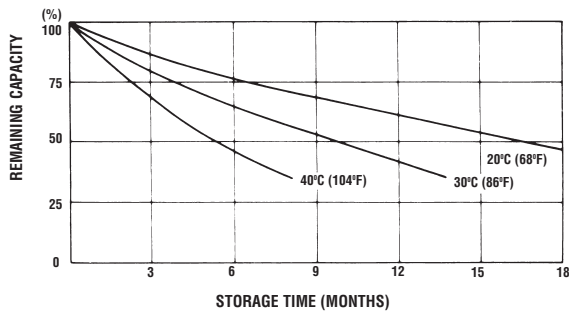

OPEN CIRCUIT VOLTAGE VS REMAINING CAPACITY

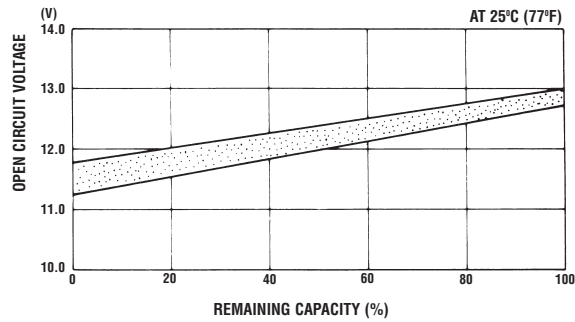

CYCLE SERVICE LIFE IN RELATION TO DEPTH OF DISCHARGE

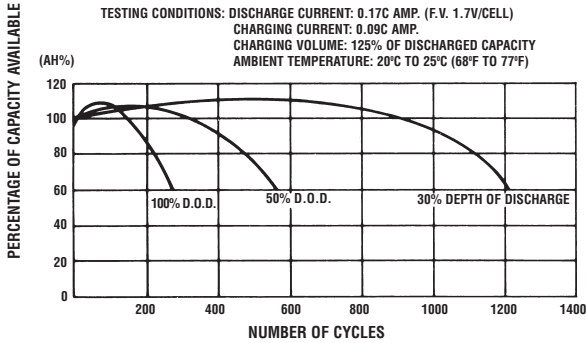

FLOAT SERVICE LIFE

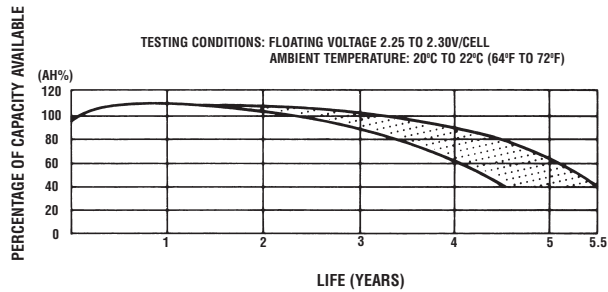

When the battery will be used by current in excess of 3C, consult with EnerSys prior to use.

CHARGING METHODS (At 20°C)

Cycle use: Maximum charging current 1.75A
Charging voltage 14.4 to 15.0V

Standby use: Float charging voltage 13.50 to 13.80V

CAUTION

- Avoid short circuit
- Do not charge in a sealed container.

www.regulacionups.com.mx



EnerSys
P.O. Box 14145
Reading, PA 19612-4145
USA
Tel: +1-610-208-1991
+1-800-538-3627

EnerSys EMEA
Brussels, Belgium
Tel: +32 (0)2 247 94 47

EnerSys Asia
Guandong, China
Tel: +86 755 689 9220

DISTRIBUIDOR:



PLAYA SUR No. 20 INT. 2
COL. MILITAR MARTE
08830 IZTACALCO MEXICO, D.F.
TEL. 7090-7088 Y 7090-7089
ventas@regulacionups.com.mx
www.regulacionups.com.mx