

GP 12170

12V 17Ah

GP 12170 is a general purpose battery up to 5 years in standby service or more than 260 cycles at 100% discharge in cycle service. As with all CSB batteries, all are rechargeable, highly efficient, leak proof and maintenance free.



Specification

Cells Per Unit	6
Voltage Per Unit	12
Capacity	17Ah @ 20hr-rate to 1.75V per cell @25 °C (77°F)
Weight	Approx. 5.5 kg(12.13 lbs)
Maximum Discharge Current	230A(5sec)
Internal Resistance	Approx. 16mΩ
Operating Temperature Range	Discharge: -15°C~50°C (5°F~122°F) Charge: -15 °C~40°C (5°F~104°F) Storage: -15°C~40°C (5°F~104°F)
Nominal Operating Temperature Range	25°C±3°C(77°F±5°F)
Float Charging Voltage	13.5 to 13.8 VDC/unit Average at 25°C (77°F)
Recommended Maximum Charging	5.1A
Current Limit	
Equalization and Cycle Service	14.4 to 15.0 VDC/unit Average at 25°C (77°F)
Self Discharge	CSB Batteries can be stored for more than 6 months at 25°C (77°F). Please charge batteries before using. For higher temperatures the time interval will be shorter.
Terminal	B1/B3-L terminal to accept M5 nut & bolt
Container Material	ABS(UL 94-HB/File E50263)*Flammability resistance of (UL 94-V0/File E88637) can be available upon request.



CSB-manufactured batteries are UL-recognized components under UL924 and UL1989. CSB is also certified by ISO 9001 and ISO 14001.

Dimensions

unit: (MM)

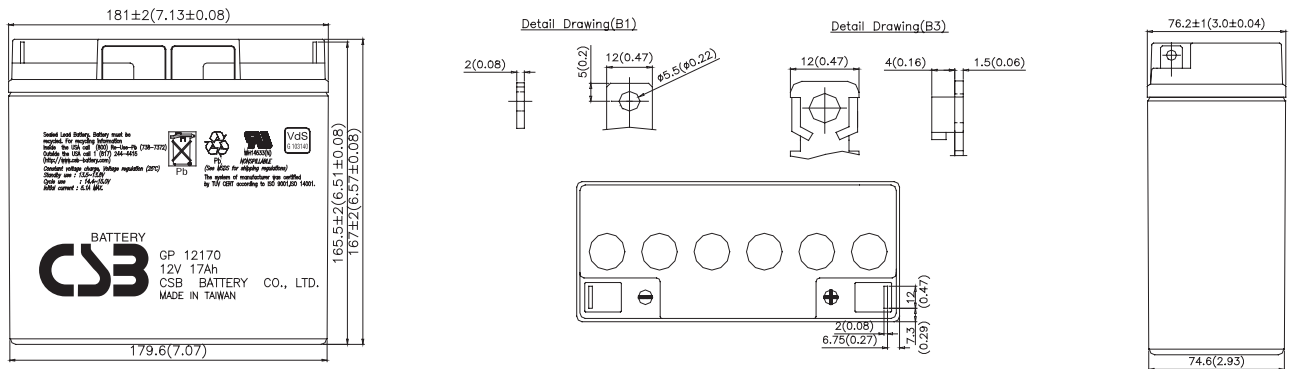

Constant Current Discharge Characteristics Unit:A (25°C,77°F)

F.V/Time	5MIN	10MIN	15MIN	30MIN	1HR	2HR	3HR	4HR	5HR	8HR	10HR	20HR
1.60V	80.2	50.9	38.5	23.4	13.8	8.03	5.72	4.44	3.63	2.37	1.93	1.00
1.67V	71.2	47.5	36.5	22.9	13.7	8.00	5.69	4.43	3.62	2.36	1.90	0.958
1.70V	67.4	45.8	35.6	22.7	13.6	7.98	5.68	4.42	3.61	2.35	1.89	0.940
1.75V	61.0	43.1	34.1	22.3	13.4	7.93	5.65	4.41	3.60	2.33	1.86	0.910
1.80V	54.5	40.2	32.7	21.8	13.3	7.87	5.61	4.38	3.58	2.30	1.83	0.880
1.85V	48.0	37.3	31.0	21.2	13.1	7.81	5.57	4.36	3.57	2.28	1.80	0.850

Constant Power Discharge Characteristics Unit:W (25°C,77°F)

F.V/Time	5MIN	10MIN	15MIN	30MIN	1HR	2HR	3HR	4HR	5HR	8HR	10HR	20HR
1.60V	890	583	449	281	166	96.4	68.6	53.3	43.6	28.4	23.1	12.0
1.67V	790	544	423	275	164	96.0	68.5	53.1	43.4	28.3	22.8	11.5
1.70V	748	527	413	272	163	95.8	68.4	53.0	43.3	28.2	22.7	11.3
1.75V	677	493	395	267	161	95.3	67.9	52.8	43.2	27.9	22.4	10.9
1.80V	605	460	377	261	160	94.6	67.3	52.6	43.0	27.6	22.0	10.5
1.85V	533	427	361	254	158	93.8	66.8	52.3	42.9	27.3	21.7	10.1

● All mentioned values are average values.
● Tolerance: X<6min(+15%~-15%),6min ≤ X<10min(+12%~-12%),10min ≤ X<60min(+8%~-8%),X ≥ 60min(+5%~-5%)

Trickle (or Float) Service Life

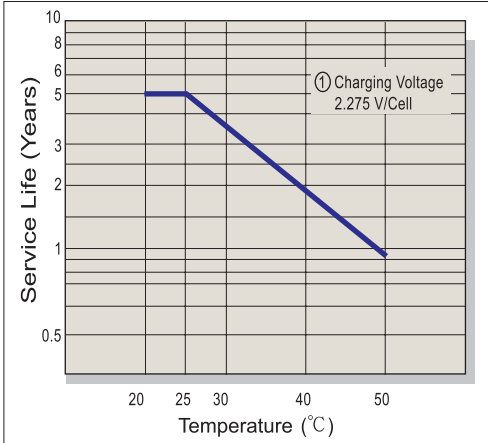

Capacity Retention Characteristic

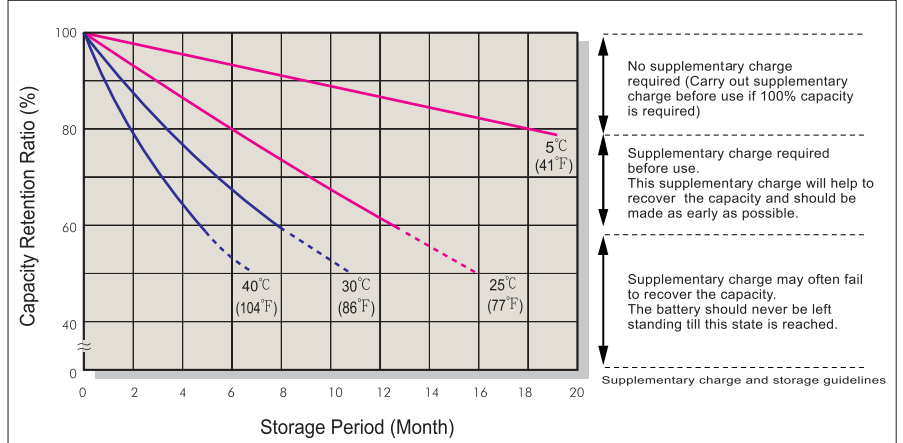

Battery Voltage and Charge Time for Standby Use

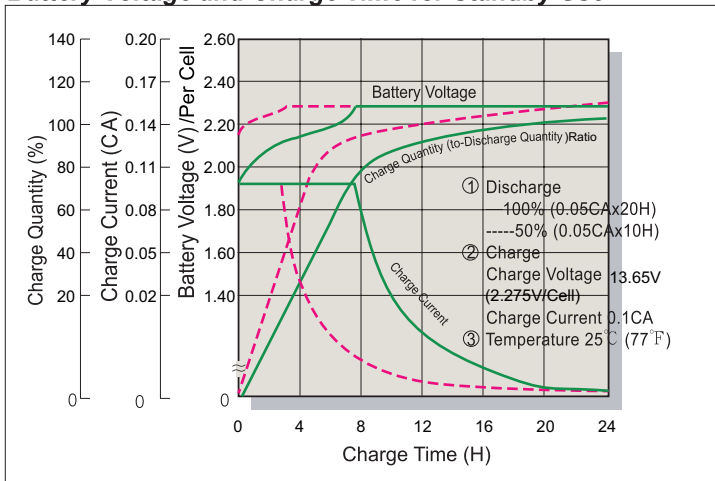

Cycle Service Life

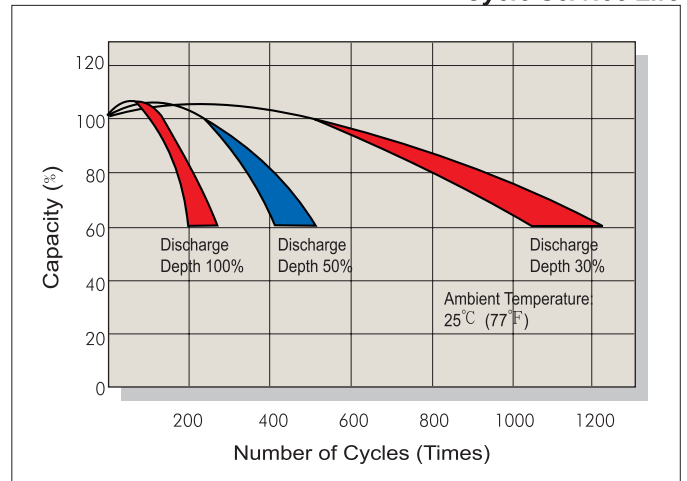

Battery Voltage and Charge Time for Cycle Use

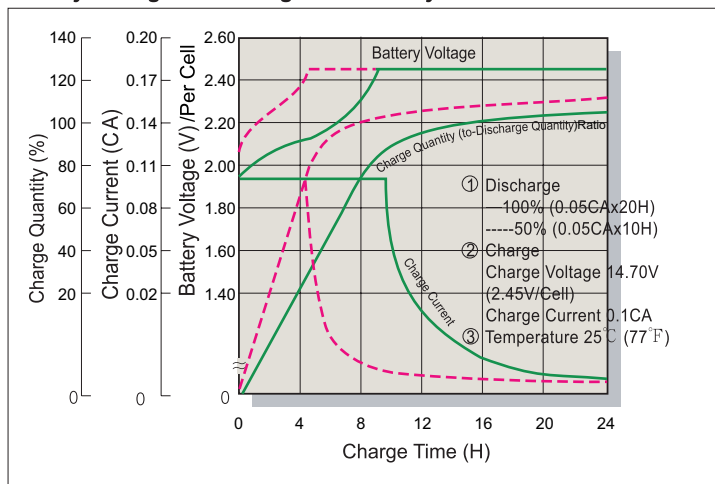

Terminal Voltage (V) and Discharge Time

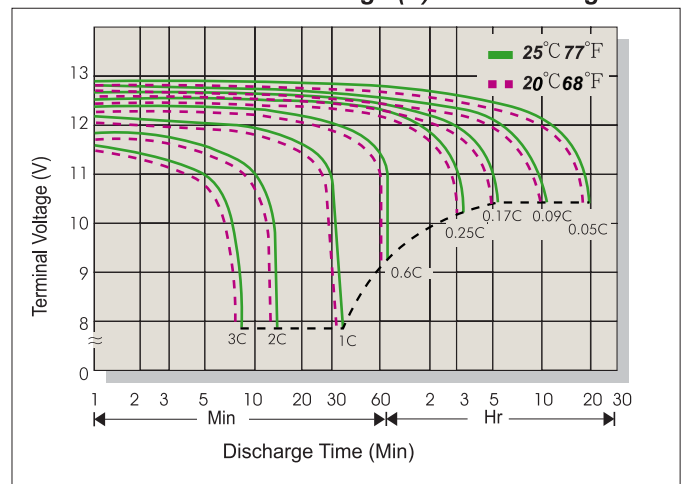

Charging Procedures

Application	Charge Voltage(V/Cell)			Max.Charge Current
	Temperature	Set Point	Allowable Range	
Cycle Use	25°C (77°F)	2.45	2.40~2.50	0.3C
Standby	25°C (77°F)	2.275	2.25~2.30	

Discharge Current VS. Discharge Voltage

Final Discharge Voltage V/Cell	1.75	1.70	1.60	1.30
Discharge Current(A)	0.2C>(A)	0.2C<(A)<0.5C	0.5C<(A)<1.0C	(A)>1.0C

Sales Office

DISTRIBUIDOR

REGULACIÓN Y SISTEMAS DE ENERGÍA S.A. DE C.V.
 ASesoría • VENTAS • SERVICIO
 PLAYA SUR No. 20 INT. 2 COL. MILITAR MARTE 08830 IZTACALCO
 MEXICO D.F. TEL.: 5698-7907 Y 9180-1990
 e-mail: ventas@regulacionups.com.mx
 www.regulacionups.com.mx